

**PLAN VIEW**

CHAMBER		Volume (gal)
①	Sedimentation Chamber	198
②	Anaerobic Filtration Chamber	198
③	Aerobic Contact Filtration Chamber	95
④	Storage Chamber	44
⑤	Disinfection Chamber	4
Total Volume		540

SPECIFICATIONS			
Anaerobic Media	PP / PE	Filling Rate	31%
Board Type Aerobic Media	PVC / PP / PE	Filling Rate	16%
Aerobic Media	PP / PE	Filling Rate	55%
Blower	2.8 cfm		
Tank	FRP		
Piping	PVC / PP / PE		
Access Covers	Plastic / Cast Iron		
Disinfectant (Optional)	Chlorine Tablets		

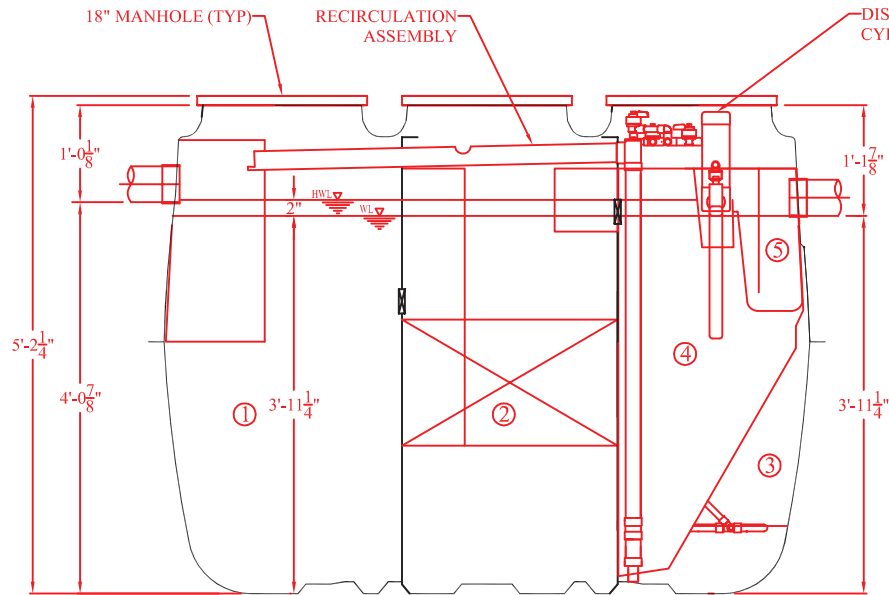

**SECTION A-A VIEW**

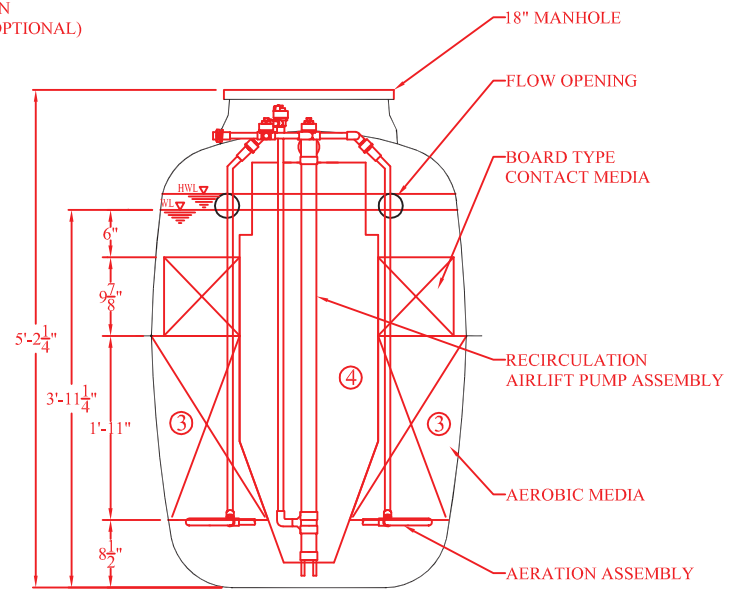

**SECTION B-B VIEW**



**CE-5 Structural Drawing**

DATE: 03/21/2014 SCALE: 1/2" = 1"