

CHAMBER		Volume (gal)
①	Sedimentation Chamber	558
②	Anaerobic Filtration Chamber	556
③	Aerobic Contact Filtration Chamber	248
④	Clarification Chamber	125
⑤	Disinfection Chamber	11
Total Volume		1,498

SPECIFICATIONS	
Anaerobic Media	PP / PE
Board Type Aerobic Media	PVC / PP / PE
Aerobic Media	PP / PE
Blower	5.3 cfm
Tank	FRP
Piping	PVC / PP / PE
Access Covers	Plastic / Cast Iron
Disinfectant (Optional)	Chlorine Tablets

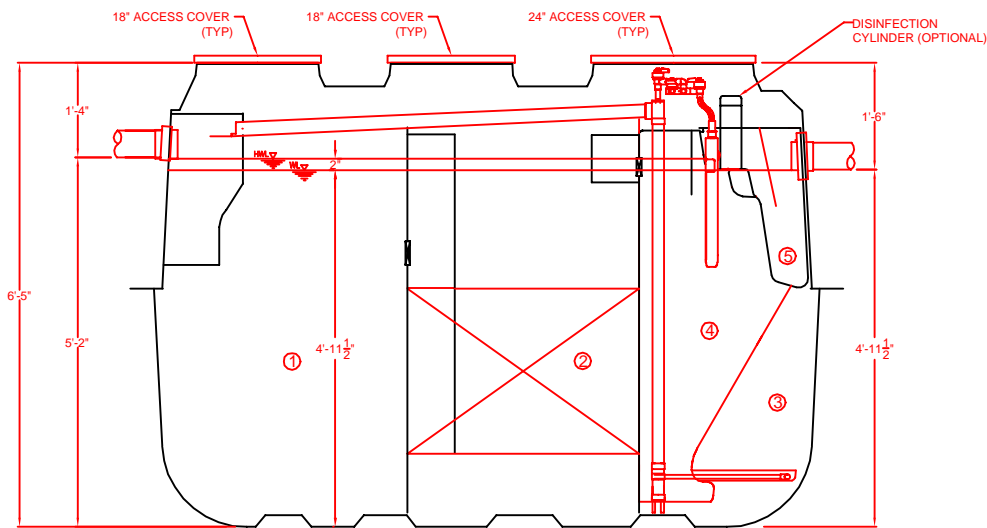

SECTION A-A VIEW

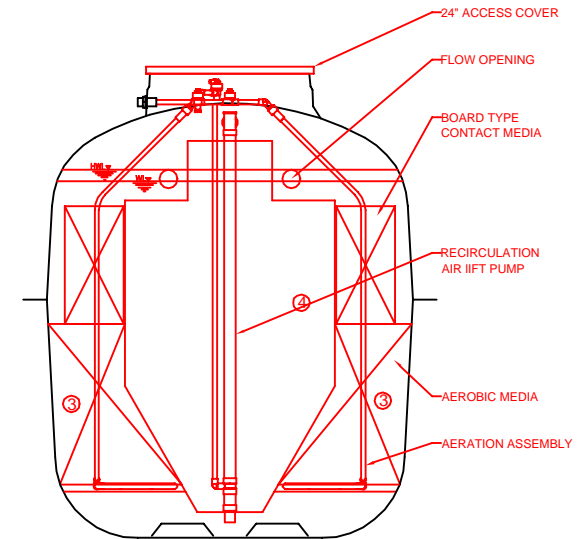

SECTION B-B VIEW



CEN-10
Structural Drawing

DATE: 03/21/2021 SCALE: 3/8" = 1'