

PLAN VIEW

CHAMBER		Volume (gal)
①	Sedimentation Chamber	397
②	Anaerobic Filtration Chamber	396
③	Aerobic Contact Filtration Chamber	181
④	Clarification Chamber	90
⑤	Disinfection Chamber	6
Total Volume		1069

SPECIFICATIONS	
Anaerobic Media	PP / PE
Board Type Aerobic Media	PVC / PP / PE
Aerobic Media	PP / PE
Blower	3.5cfm
Tank	FRP
Piping	PVC / PP / PE
Access Covers	Plastic / Cast Iron
Disinfectant (Optional)	Chlorine Tablets

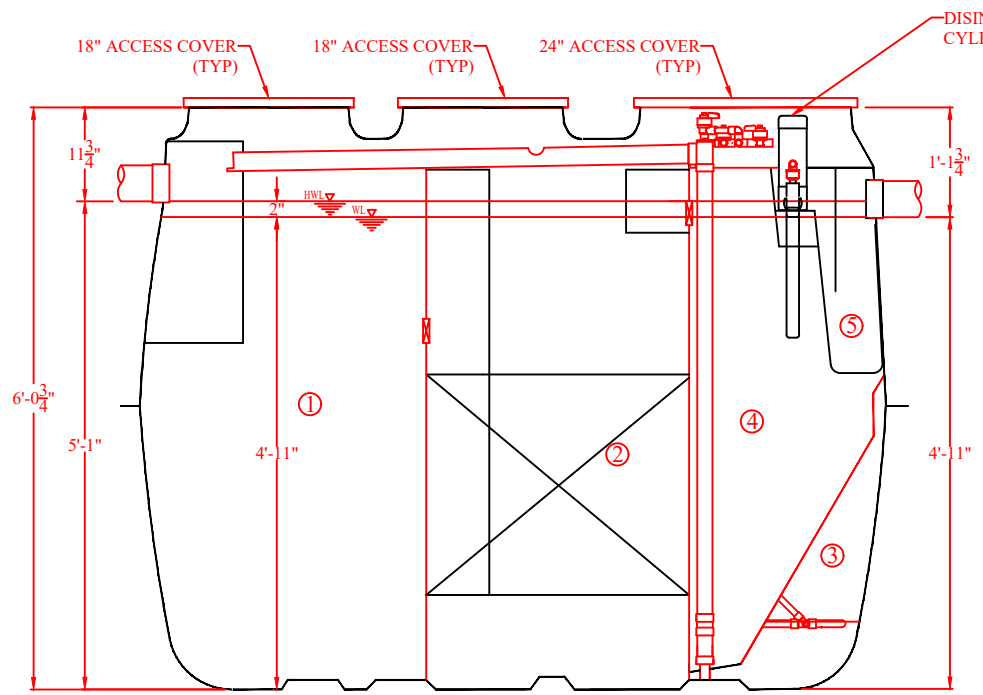

SECTION A-A VIEW

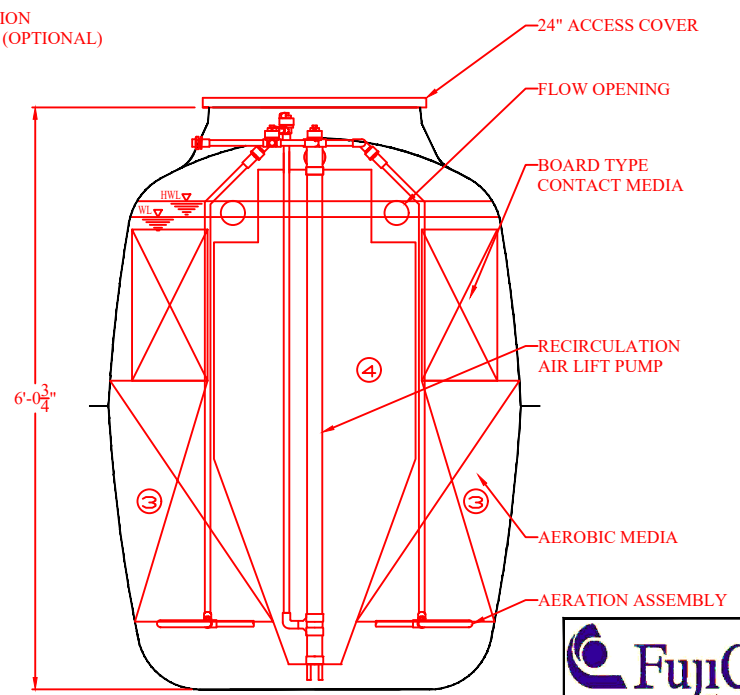

SECTION B-B VIEW



CEN-7
Structural Drawing

DATE: 09/28/2020 SCALE: 1/2" = 1"